

VS-KB30 Keyboard Controller

User Manual - English



[Important]

To download the latest version of Quick Start Guide, multilingual user manual, software, or driver, etc., please visit Lumens <http://www.MyLumens.com>

Table of Contents

Copyright Information	3
Chapter 1 Safety Instructions	4
Chapter 2 Product Overview	6
2.1 I/O Introduction	6
2.2 Panel Function Introduction.....	7
2.3 LCD Screen Display Description	9
Chapter 3 LCD Function Menu Description	10
3.1 Access LCD Function Menu.....	10
3.2 Camera Setting.....	10
3.3 Keyboard setting	11
Chapter 4 Camera Connection Description	14
4.1 Port Pin Definition.....	14
4.2 How to Connect RS-232.....	14
4.3 How to Connect RS-422.....	15
4.4 How to Connect IP	15
Chapter 5 Camera Setting Description	16
5.1 Power on VS-KB30	16
5.2 Instruction on RS-232 Setting	16
5.3 Instruction on RS-422 Setting	17
5.4 Instruction on IP Setting	17
Chapter 6 Descriptions of Major Functions	19
6.1 Call the Camera.....	19
6.2 Setup/Call/Cancel Preset Position.	20
6.3 Set the Non-IP Camera OSD Menu via Keyboard	21

6.4 Set the PELCO-D Camera OSD Menu via Keyboard 21

6.5 RS422 Set A, Set B Switching..... 22

Chapter 7 Troubleshooting..... 23

Supplier's Declaration of Conformity 47 CFR § 2.1077 Compliance
Information 24

Copyright Information

Copyrights © Lumens Digital Optics Inc. All rights reserved.

Lumens is a trademark that is currently being registered by Lumens Digital Optics Inc.

Copying, reproducing or transmitting this file is not allowed if a license is not provided by Lumens Digital Optics Inc. unless copying this file is for the purpose of backup after purchasing this product.

In order to keep improving the product, Lumens Digital Optics Inc. hereby reserves the right to make changes to product specifications without prior notice. The information in this file is subject to change without prior notice.

To fully explain or describe how this product should be used, this manual may refer to names of other products or companies without any intention of infringement.

Disclaimer of warranties: Lumens Digital Optics Inc. is neither responsible for any possible technological, editorial errors or omissions, nor responsible for any incidental or related damages arising from providing this file, using, or operating this product.

Chapter 1 Safety Instructions





Always follow these safety instructions when setting up and using the HD Camera:

1. Use attachments only as recommended.
2. Use the type of power source indicated on this product. If you are not sure of the type of power available, consult your distributor or local electricity company for advice.
3. Always take the following precautions when handling the plug. Failure to do so may result in sparks or fire:
 - Ensure the plug is free of dust before inserting it into a socket.
 - Ensure that the plug is inserted into the socket securely.
4. Do not overload wall sockets, extension cords or multi-way plug boards as this may cause fire or electric shock.
5. Do not place the product where the cord can be stepped on as this may result in fraying or damage to the lead or the plug.
6. Never allow liquid of any kind to spill into the product.
7. Except as specifically instructed in this User Manual, do not attempt to operate this product by yourself. Opening or removing covers may expose you to dangerous voltages and other hazards. Refer all servicing to licensed service personnel.
8. Unplug the HD Camera during thunderstorms or if it is not going to be used for an extended period. Do not place the HD Camera or remote control on top of vibrating equipment or heated objects such as a car, etc.
9. Unplug the HD Camera from the wall outlet and refer servicing to licensed service personnel when the following situations happen:
 - If the power cord or plug becomes damaged or frayed.
 - If liquid is spilled into the product or the product has been exposed to rain or water.

■ Precautions

Warning: To reduce the risk of fire or electric shock, do not expose this appliance to rain or moisture.

If the keyboard controller will not be used for an extended time, unplug it from the power socket.

	<div style="border: 1px solid black; padding: 5px; margin-bottom: 5px;">Caution</div> <div style="background-color: black; color: white; padding: 5px;">Risk of Electric Shock Please do not open it by yourself.</div>		
<p>Caution: To reduce the risk of electric shock, do not remove cover (or back). No user-serviceable parts inside. Refer servicing to licensed service personnel.</p>			
	<p>This symbol indicates that this equipment may contain dangerous voltage which could cause electric shock.</p>		<p>This symbol indicates that there are important operating and maintenance instructions in this User Manual with this unit.</p>

■ FCC Warning

This HD Camera has been tested and found to comply with the limits for a Class B computer device, pursuant to Article 15-J of FCC Rules. These limits are designed to provide reasonable protection against harmful interference in a residential installation.

This digital apparatus does not exceed the Class B limits for radio noise emissions from digital apparatus as set out in the interference-causing equipment standard entitled “Digital Apparatus,” ICES-003 of Industry Canada.

Cet appareil numérique respecte les limites de bruits radioélectriques applicables aux appareils numériques de Classe B prescrites dans la norme sur le matériel brouilleur: “Appareils Numériques,” NMB-003 édictée par l’Industrie.

Chapter 2 Product Overview

2.1 I/O Introduction

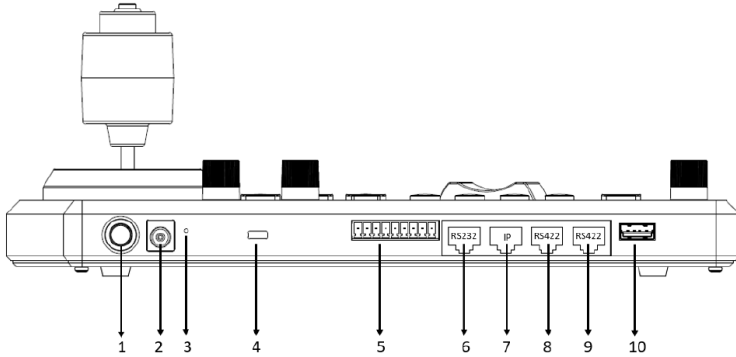

No	Item	Function Descriptions
1	Power button	Turn on/off keyboard power
2	12 V DC power port	Connect the included DC power supply adapter and the power cable
3	Firmware update button	Enable the firmware update mode on the keyboard
4	Kensington safety lock	Use the safety lock to lock the keyboard for anti-theft purpose
5	Tally indicator light port	Tally indicator control interface
6	RS232 port	Connect the RS232 adapter cable
7	IP port	Connect the RJ45 network cable
8	RS422 (B) port	Connect the RS422 adapter cable that can control up to 7 units of RS422 camera (Set B)
9	RS422 (A) port	Connect the RS422 adapter cable that can control up to 7 units of RS422 camera (Set A)
10	USB port	Update the keyboard control firmware via a USB disk

2.2 Panel Function Introduction

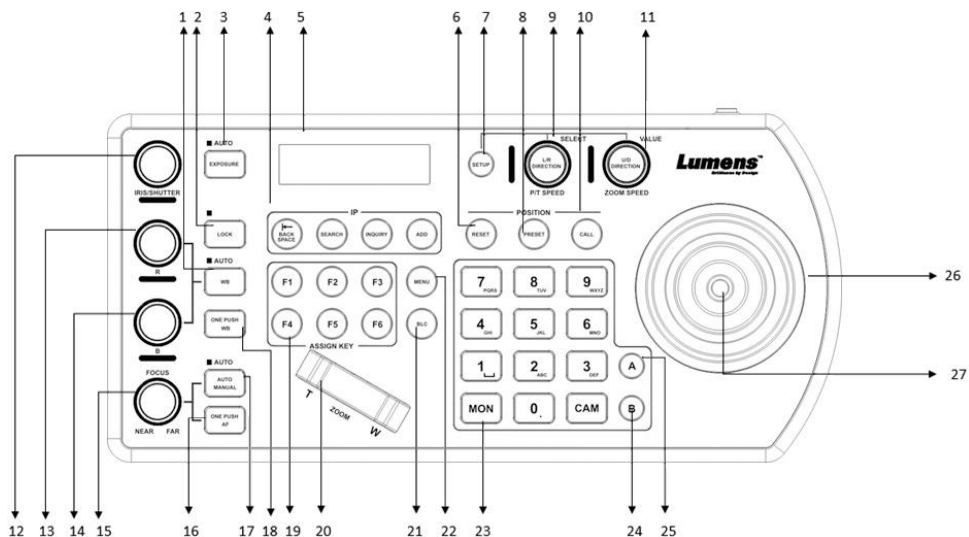

No	Item	Function Descriptions
1	WB	Automatic/manual white balance switch When the setting is automatic white balance, the AUTO indicator will turn on
2	LOCK	Lock the control of all image adjustment and rotary buttons Press and hold for 3 seconds to enable the lock; press and hold for 3 seconds again to cancel the lock
3	EXPOSURE	Auto, Aperture PRI, Shutter PRI
4	IP SETTING BUTTON	Search or add the camera IP setting
5	LCD SCREEN	Display control and setting information of the keyboard
6	RESET	Clear the camera preset position (number key + RESET, press and hold for 3 seconds)
7	SETUP	Set the keyboard menu (initial password is 0000)
8	PRESET	Store the camera preset position (number key + PRESET, press and hold for 3 seconds)
9	P/T SPEED (L/R DIRECTION)	Rotate: Adjust/control the speed (on screen menu) Press: Select OK (on screen menu) Press and hold: Pan right and left and to reverse the direction

No	Item	Function Descriptions
10	CALL	Call the camera preset position (number key + CALL)
11	ZOOM SPEED (U/D DIRECTION)	Rotate: Adjust the zoom speed/adjustment value (on screen menu) Press: Save (on screen menu) Press and hold: Tilt up and down and to reverse the direction
12	IRIS / SHUTTER	Adjust the aperture or shutter
13	R VALUE	Adjust the white balance in red manually
14	B VALUE	Adjust the white balance in blue manually
15	FOCUS	Manual focus
16	ONE PUSH AF	One push focus
17	AUTO / MANUAL	Automatic/manual focus switch When the setting is automatic focus, the AUTO indicator will turn on.
18	ONE PUSH WB	One push white balance
19	ASSIGN KEY	Set up the shortcut key to quickly control the camera
20	ZOOM SEESAW	Control ZOOM in/out
21	BLC	Enable/disable background light compensation in the camera
22	MENU	Call the camera OSD menu
23	LETTER AND NUMBER KEYBOARD	CALL a camera; call a preset position; key in the camera name (on screen menu)
24	RS422 SET B SELECTION	RS422 set B selection
25	RS422 SET A SELECTION	RS422 set A selection
26	PTZ JOYSTICK	Control the camera PTZ operation.
27	CAMERA CONTROL BUTTON	When using PTZ joystick to control OSD menu, press the button to confirm (same function as the Enter key of a remote control)

2.3 LCD Screen Display Description

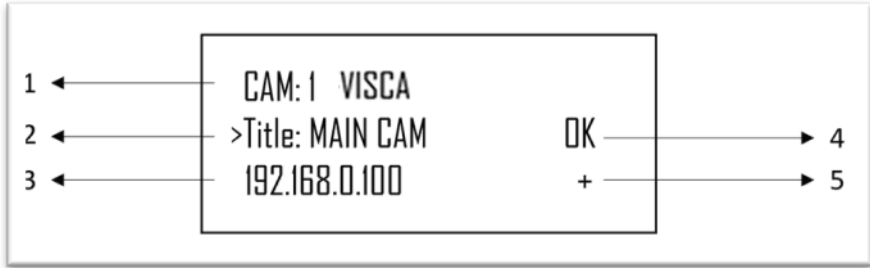

No	Item	Function Descriptions
1	Camera ID and protocol	Display the camera currently under control and the protocol currently in use
2	Camera name	Display the specified camera name currently in use
3	IP address	Current IP address of the camera
4	Communication status of the connected device	If "OK" is displayed, communication with the current device has been established If "NO" is displayed, there is no connection with the current device
5	Network connection indication status	If "+" is displayed, the network is connected successfully If "+" is not displayed, the network is not connected correctly

Chapter 3 LCD Function Menu Description

3.1 Access LCD Function Menu

Press the SETUP button on the keyboard to access the LCD function menu.

※ When configuring the LCD menu setting, you must key in the password every time (initial password is 0000)

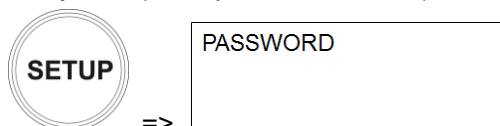

3.2 Camera Setting

■ CAMERA SETTING

Item	Settings	Description
CAM	1 ~ 255	Assign the camera number; 255 units can be set at most
Title	-	The camera can be named using letters on the keyboard
Protocol	VISCA PELCO-D PELCO-P VISCAIP	Select a control protocol to be used for connecting the camera

■ VISCA / PELCO-D / PELCO-P advanced setting

Item	Settings	Description
Baud Rate	2400 4800 9600 19200 38400	When selecting VISCA / PELCO-D / PELCO-P as the control protocol, the Baud rate transmission speed must be specified
Port	RS232 / RS422	Set the control method of VISCA control

■ VISCAIP advanced setting

Item	Settings	Description
IP Address	<u>192.168.0.168</u>	Set the camera IP address

3.3 Keyboard setting

■ IP Configuration Menu

Item	Settings	Description
Type	STATIC / DHCP	Specify a static IP or let DHCP to assign an IP to the keyboard
IP Address	192.168.0.100	For a static IP, specify the IP address in this field (Default IP is 192.168.0.100)
Subnet Mask	255.255.255.0	For a static IP, specify the subnet mask in this field
Gateway	192.168.0.1	For a static IP, specify the gateway in this field

■ BUTTON LIGHT

Item	Settings	Description
Level	1 / <u>2</u> / 3	Set background brightness of the keyboard buttons

■ ASSIGNED KEY

Item	Settings	Description
F1 ~ F6	Camera 1 ~ 6 Home P/T Reset Power Mute Picture Freeze Picture Flip Picture LR_Reverse None	F1 ~ F6 buttons can be set as shortcut keys separately Functions may be set as the list displayed to the left Press the shortcut key and the camera will perform the specified function quickly

■ FACTORY DEFAULT

Item	Settings	Description
FACTORY DEFAULT	Yes / No	Execute the factory reset on the keyboard LCD menu functions After the reset is completed, "Succeed" will be displayed ※ When executing the factory reset, do not move the PTZ joystick and the ZOOM in/out button

■ GPI I/O

Item	Settings	Description
Setting	Input / Output	Set the control signal direction of GPI I/O interface as Input or Output
Tally Mode	Normal / On Air	Display the Tally input indicator that corresponds to the camera number having the Tally input as ON. When the setting is Normal, the camera is selected as the target camera automatically
Command Sel	Standard / Expand	Set the camera number to be standard or binary processing
Camera Link	On / Off	Enable or disable Tally indicator control

■ PASSWORD SETTING

Item	Description
Old Password	Key in the current password (initial password is 0000)
New Password	Key in a new password
Confirm	Enter the new password again
Save	Preset Save

■ JOYSTICK ZOOM

Item	Settings	Description
JOYSTICK ZOOM	ON / OFF	Specify whether to enable the joystick ZOOM function

■ MODEL INFO

Item	Description
<pre>>IP Address : 192. 168. 0. 100 FW Version : 0.6.7L IP V2.5 Exit</pre>	Display the IP address that controls the keyboard and FW version

Chapter 4 Camera Connection Description

VS-KB30 supports crossing protocol hybrid control between RS232, RS422 and IP.

Supported control protocols include: VISCA, PELCO D / P, VISCA over IP

4.1 Port Pin Definition

TALLY/CONTACT		RS-232			IP			RS-422 (A/B)		
Pin No.	Function	Pin No.	Function	Color	Pin No.	Function	Color	Pin No.	Function	Color
1	CAMERA1	1	-	Orange/White	1	TX+	Orange/White	1	TX-	Orange/White
2	CAMERA2	2	-	Orange	2	TX-	Orange	2	TX+	Orange
3	CAMERA3	3	GND	Green/White	3	RX+	Green/White	3	GND	Green/White
4	CAMERA4	4	-	Blue	4	n/c	Blue	4	-	Blue
5	CAMERA5	5	-	Blue/White	5	n/c	Blue/White	5	-	Blue/White
6	CAMERA6	6	GND	Green	6	RX-	Green	6	-	Green
7	CAMERA7	7	TXD	Brown/White	7	n/c	Brown/White	7	RX-	Brown/White
8	GND	8	RXD	Brown	8	n/c	Brown	8	RX+	Brown
9	GND									

4.2 How to Connect RS-232

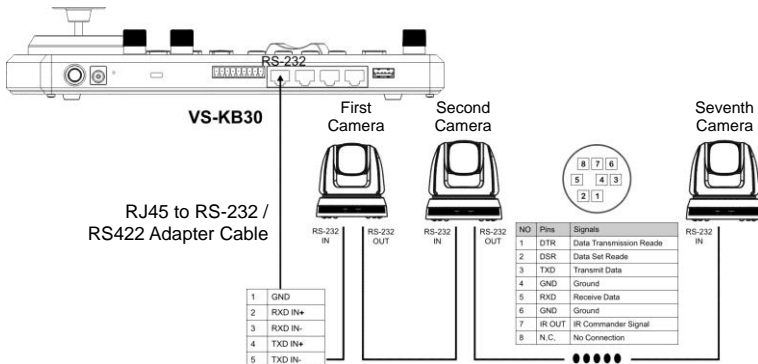

1. Connect the RJ-45 to RS232 adapter cable to the RS232 port of VS-KB30
2. Please refer to the RJ-45 to RS232 adapter cable and camera Mini Din RS232 pin definitions to complete the cable connection

[Remark] Please make sure that SYSTEM SWITCH DIP1 and DIP3 on the bottom of Lumens camera are set as OFF (RS232 & baud rate 9600)

[Note] VC-AC07 is optional and can be connected via network cable

4.3 How to Connect RS-422

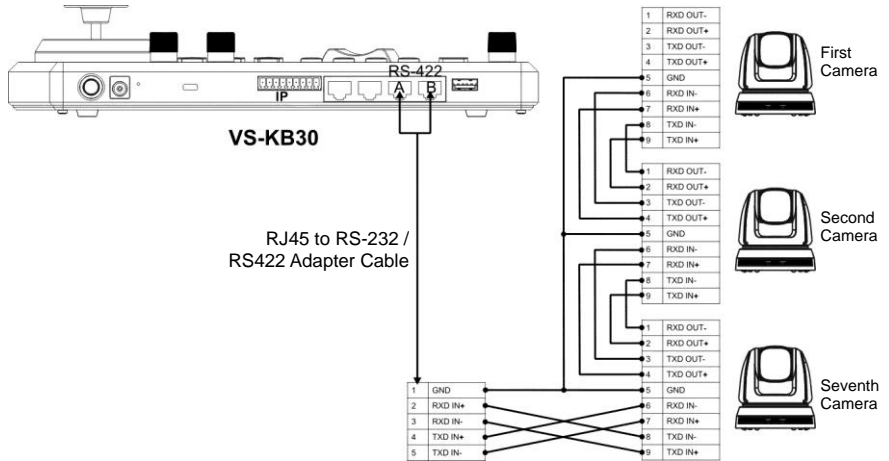

1. Connect the RJ-45 to RS232 adapter cable to the RS422 port of VS-KB30 (A or B)
2. Please refer to the RJ-45 to RS232 adapter cable and camera RS422 pin definitions to complete the cable connection

[Remark] Please make sure that SYSTEM SWITCH DIP1 and DIP3 on the bottom of Lumens camera are set as ON and OFF respectively (RS422 & baud rate 9600)

4.4 How to Connect IP

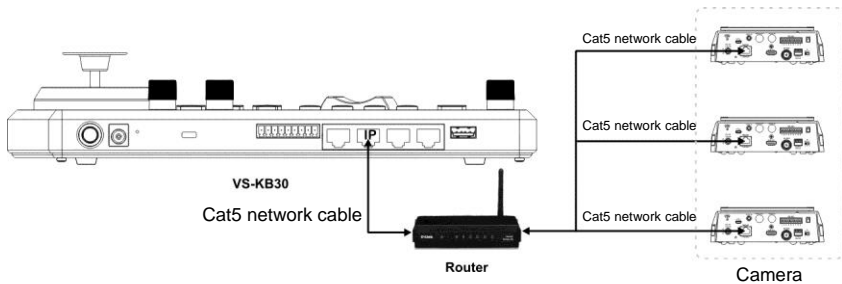

1. Use network cables to connect VS-KB30 and IP camera to the router

Chapter 5 Camera Setting Description

5.1 Power on VS-KB30

Two types of power supply can be used by VS-KB30

- DC 12 V power supply: Please use the included DC power supply adapter and power cable, and press the power button

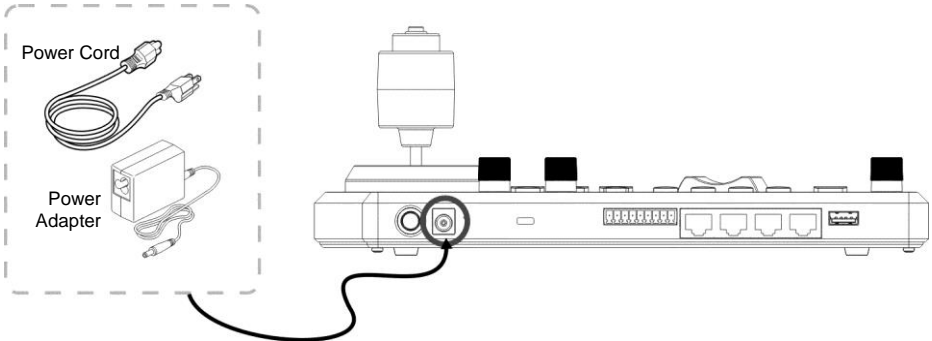

- POE power supply: Use Ethernet cables to connect POE switch and IP port of VS-KB30, and press the POWER button

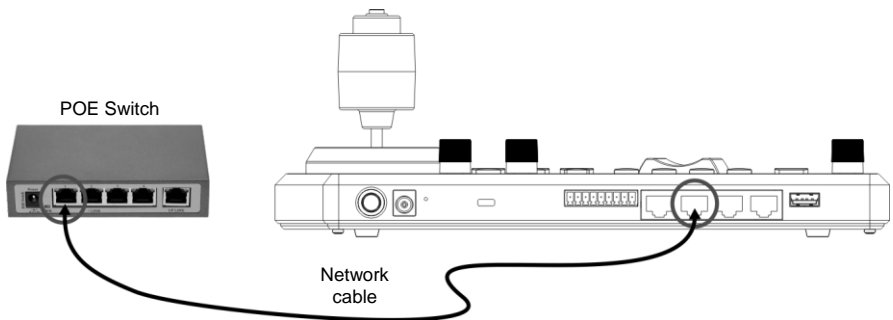

[Note] RJ45 ports of RS232 and RS422 do not support POE. Please do not connect with POE-powered network cables

5.2 Instruction on RS-232 Setting

- Press SETUP, and select CAMERA SETTING
- Set CAMID and Title
- After protocol is set as VISCA, press P/T SPEED to access the advanced setting

- Baud Rate is set as 9600
- Port is set as RS232
- Press EXIT to exit

5.3 Instruction on RS-422 Setting

- Press SETUP, and select CAMERA SETTING
- Set CAMID and Title
- After protocol is set as VISCA, press P/T SPEED to access the advanced setting
 - Baud Rate is set as 9600
 - Port is set as RS422
- Press EXIT to exit

5.4 Instruction on IP Setting

5.4.1 Set VS-KB30 IP address

- Press SETUP, and select KEYBOARD SETTING => IP CONFIGURATION
- Type: Select STATIC or DHCP
- IP Address: If select STATIC, use P/T SPEED to choose the location, input IP address via numbers on the keyboard. Last, press ZOOM SPEED to save and exit

5.4.2 Add Cameras

1. Automatic Search

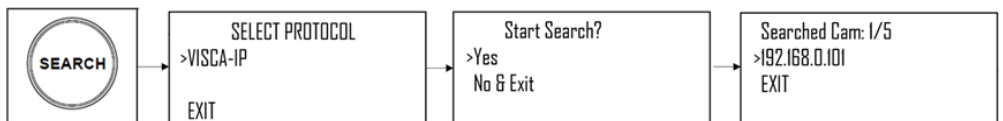

- Press SERTCH
- Select VISCA-IP
 - VISCA-IP: Search available VISCA over IP cameras on the internet
- Press ZOOM SPEED to save; then press EXIT to exit

2. Manual Add

- Press SETUP, and select CAMERA SETTING
- Set CAMID and Title
- Protocol Select VISCA-IP, and set the camera IP address
- Press ZOOM SPEED to save; then press EXIT to exit

Chapter 6 Descriptions of Major Functions

6.1 Call the Camera

6.1.1 Use the digital keyboard to call the camera

1. Key in the camera number to be called via keyboard
2. Press the “CAM” button

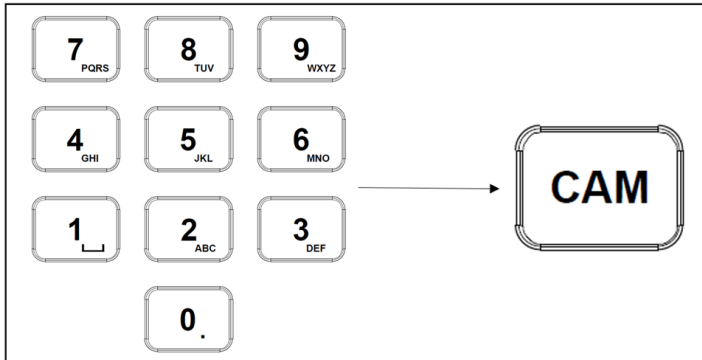

6.1.2 Call the IP camera via device list

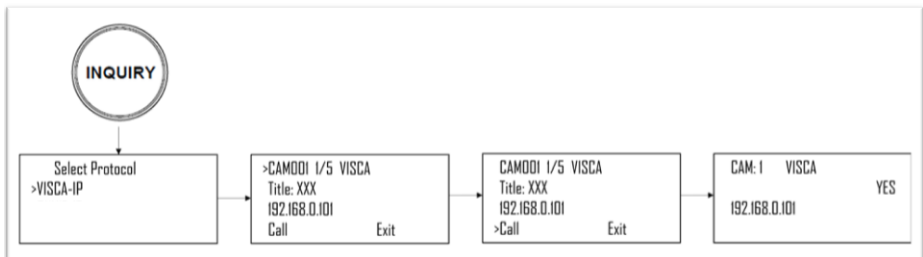

1. Press the “INQUIRY” button
2. Select the IP camera protocol
3. Use the ZOOM SPEED button to select the camera to be controlled
4. Select “CALL” and press the P/T SPEED button to confirm

6.2 Setup/Call/Cancel Preset Position.

6.2.1 Specify the preset position

1. Relocate the camera to the desired position
2. Enter the desired preset position number, then press and hold the PRESET button for 3 seconds to save

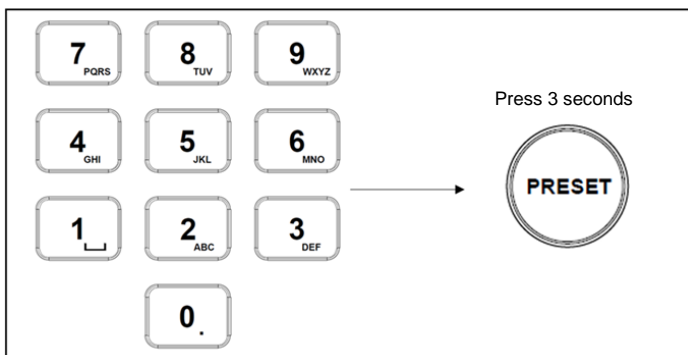

6.2.2 Call the preset position

1. Key in the desired preset position number via keyboard
2. Press "CALL" button

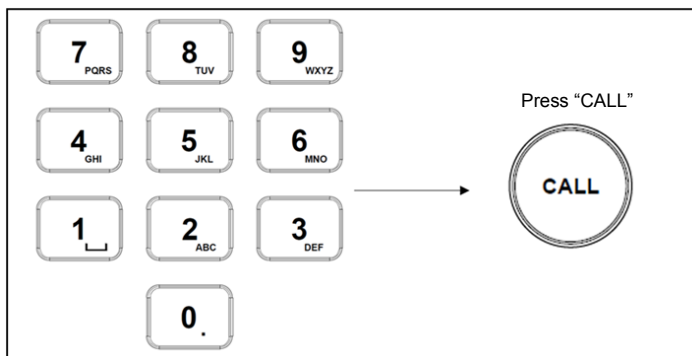

6.2.3 Cancel the preset position

1. Key in the preset position number to be deleted
2. Press "RESET" button

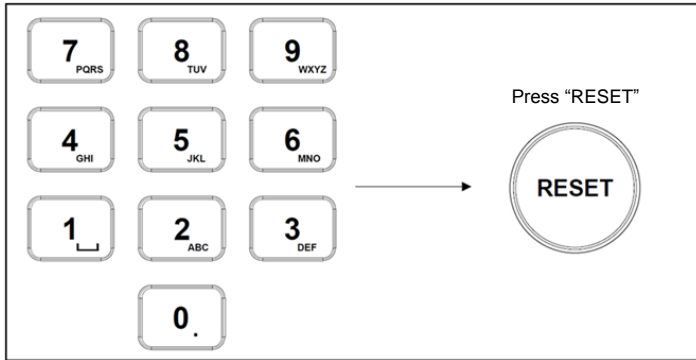

6.3 Set the Non-IP Camera OSD Menu via Keyboard

1. Press the "MENU" button on the keyboard
2. Set the camera OSD menu via PTZ joystick
 - Move the joystick up and down. Switch the menu items/Tune the parameter values
 - Move the joystick to the right: Enter
 - Move the joystick to the left: Exit

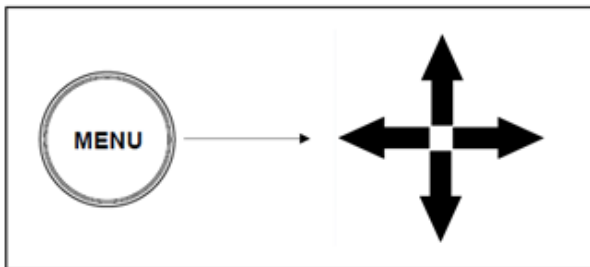

6.4 Set the PELCO-D Camera OSD Menu via Keyboard

1. Use the numeric keyboard to key in "95" + "CALL" button

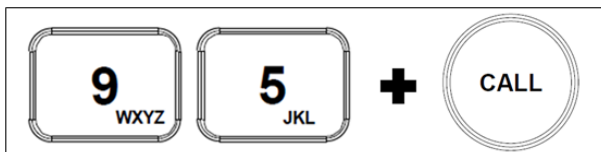

6.5 RS422 Set A, Set B Switching

1. Press the A or B buttons to switch between RS422 sets (buttons of the set in use will be lit)

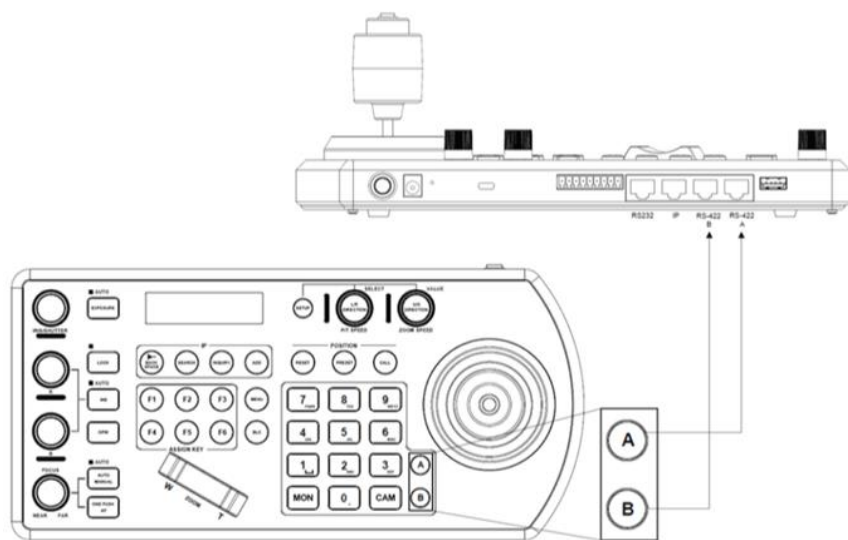

Chapter 7 Troubleshooting

This Chapter describes questions frequently asked during the use of VS-KB30 and suggests methods and solutions.

No.	Problems	Solutions
1	After plugging in the power supply, VS-KB30 power is not on	<ol style="list-style-type: none">1. Please check whether the power button on the back is pressed down correctly2. If POE is used, please make sure the Ethernet network cable is correctly connected to the power port of the POE switch
2	VS-KB30 camera cannot be controlled	<ol style="list-style-type: none">1. Please confirm the port pin connection is correct (RS-232/422)2. Please confirm whether the camera system switch DIP 1 ad DIP 3 are set correctly.3. Please confirm whether the MENU button on the keyboard is pressed down by mistake, causing the camera OSD menu to open and the camera unable to be controlled
3	Cannot use the keyboard buttons to change the image settings or focus	Please confirm the LOCK button is set in "LOCK" mode

※For questions about the installation, please scan the following QR Code. A support person will be assigned to assist you



SERVICE

Supplier's Declaration of Conformity

47 CFR § 2.1077 Compliance Information

Manufacturer: Lumens Digital Optics Inc.

Product Name: VS-KB30

Model Number: Keyboard Controller

Responsible Party - U.S. Contact Information

Supplier: Lumens Integration, Inc.

4116 Clipper Court, Fremont, CA 94538, United States

e-mail : support@mylumens.com

FCC Compliance Statement

This device complies with Part 15 of the FCC Rules. Operation is subject to the following two conditions: (1) This device may not cause harmful interference, and (2) this device must accept any interference received, including interference that may cause undesired operation.